

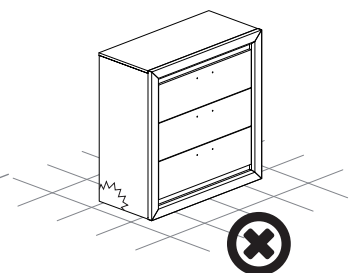

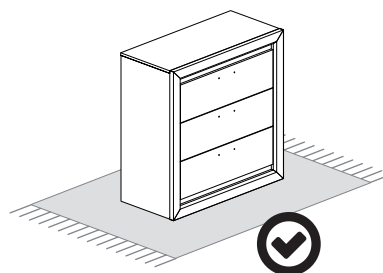

OPTIMAL 13

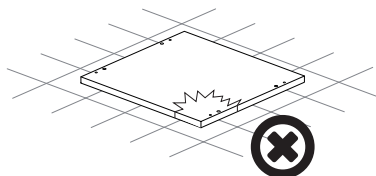

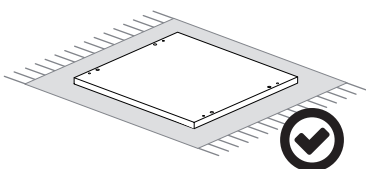
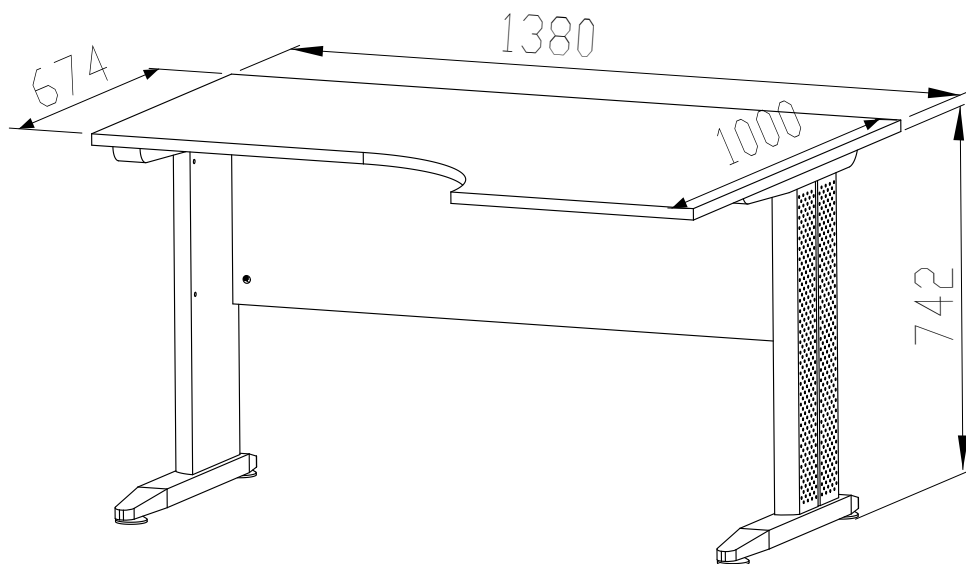
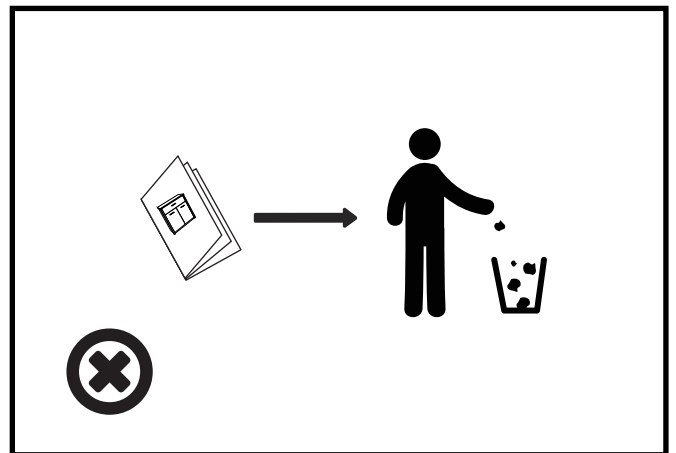
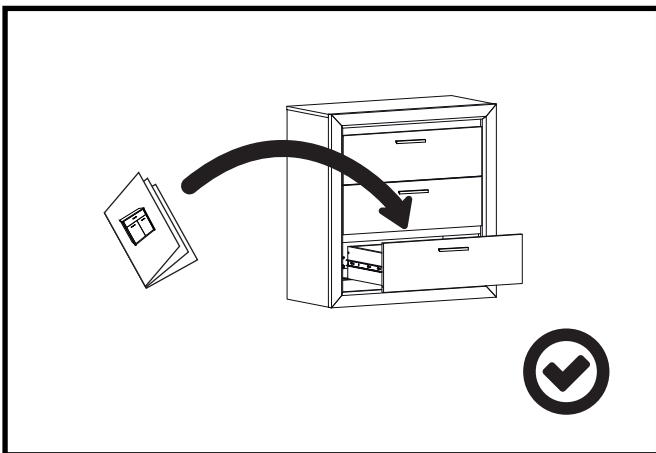
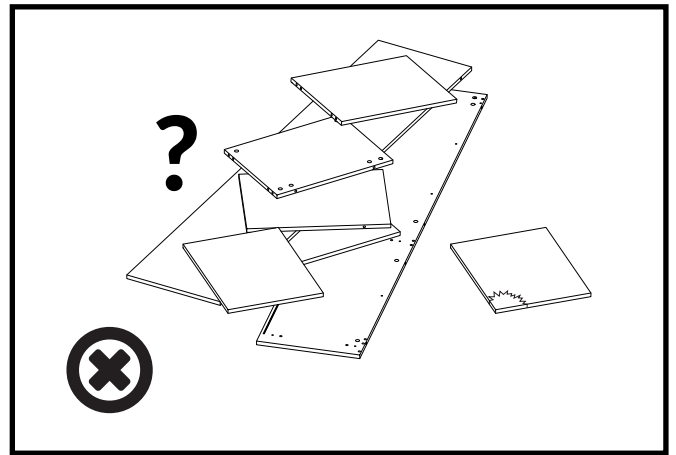
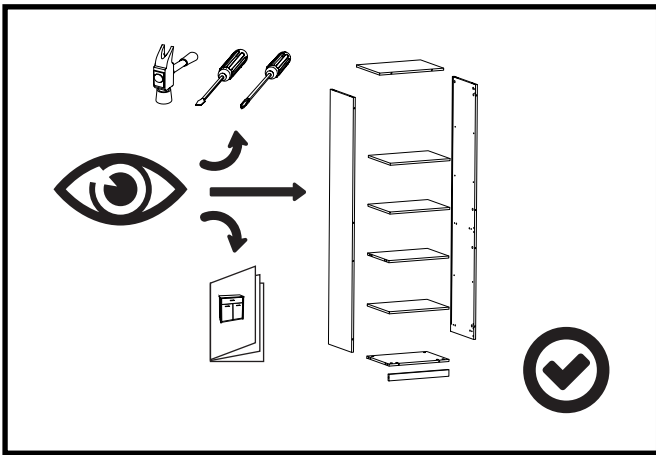
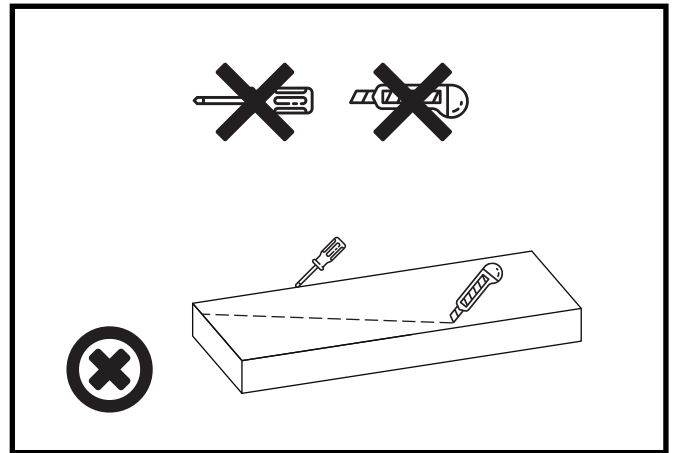
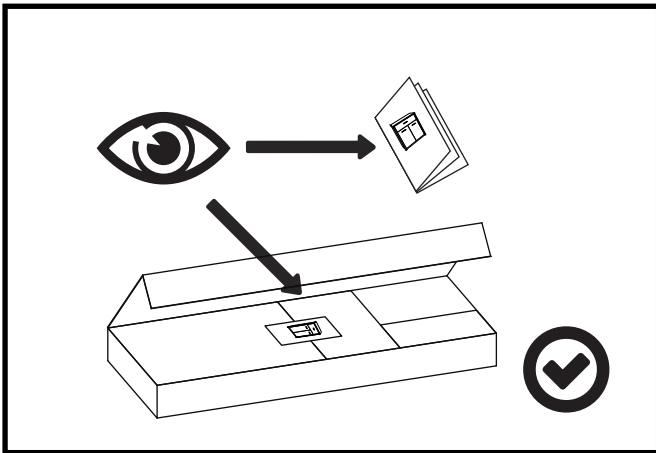
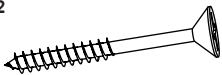
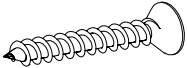

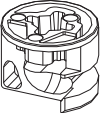

OPTIMAL 13

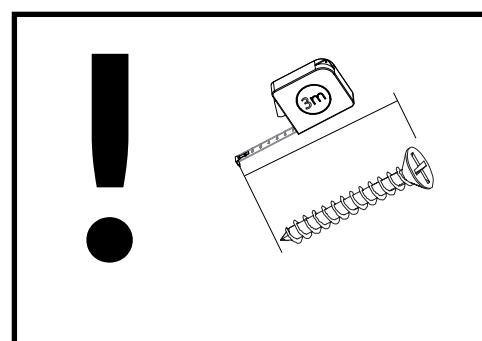
<p>WT33 x 2 5x55</p> 	<p>WT32 x 2 5x40</p> 	<p>ZS2 x 4</p> 
<p>ZM6 x 4</p> 	<p>B2 x 4</p> 	<p>x 1</p> 

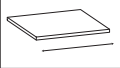
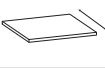

OPTIMAL 13

			
1	1380	1000	1
2	1200	334	1

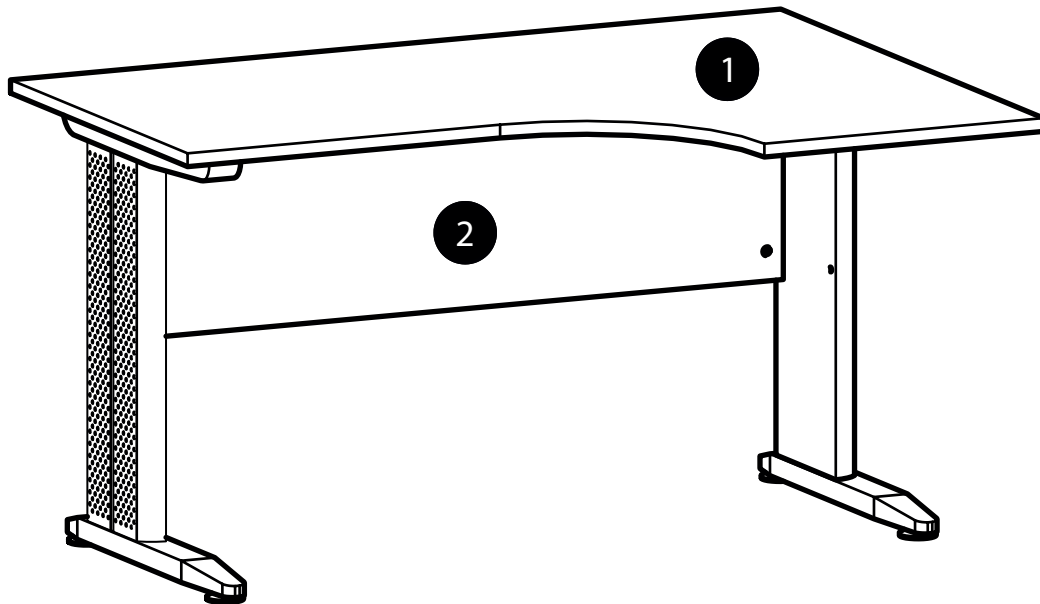

A ▶

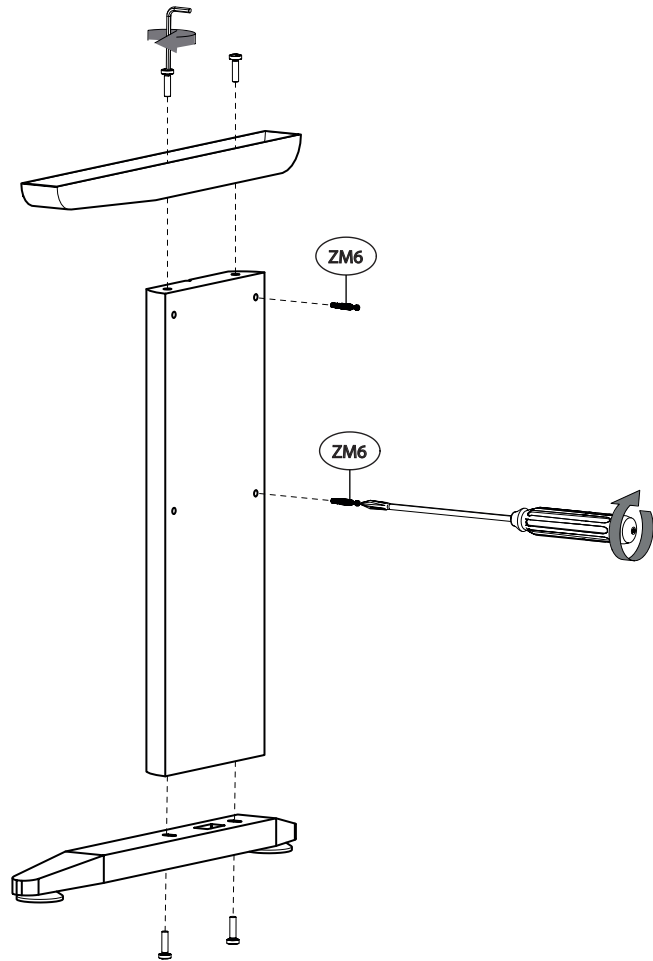

B ▶

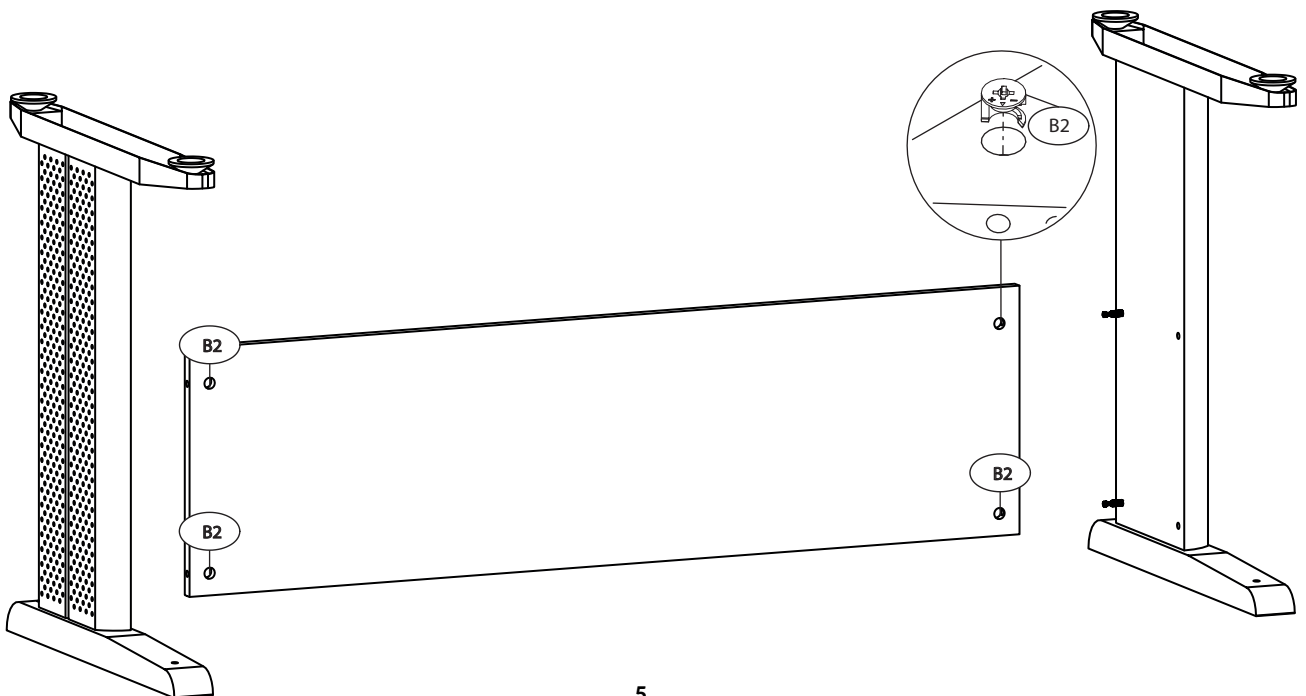
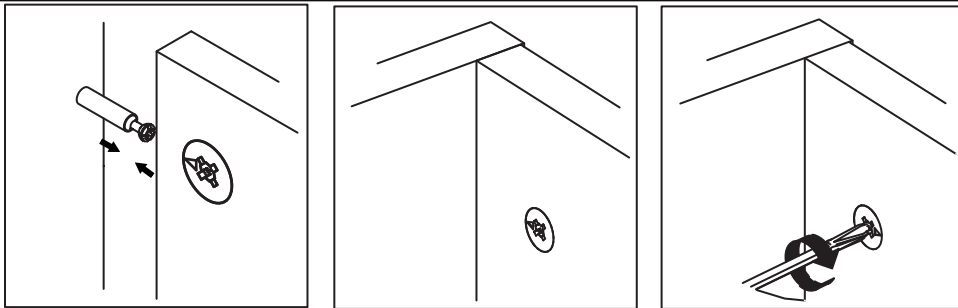

C ▶

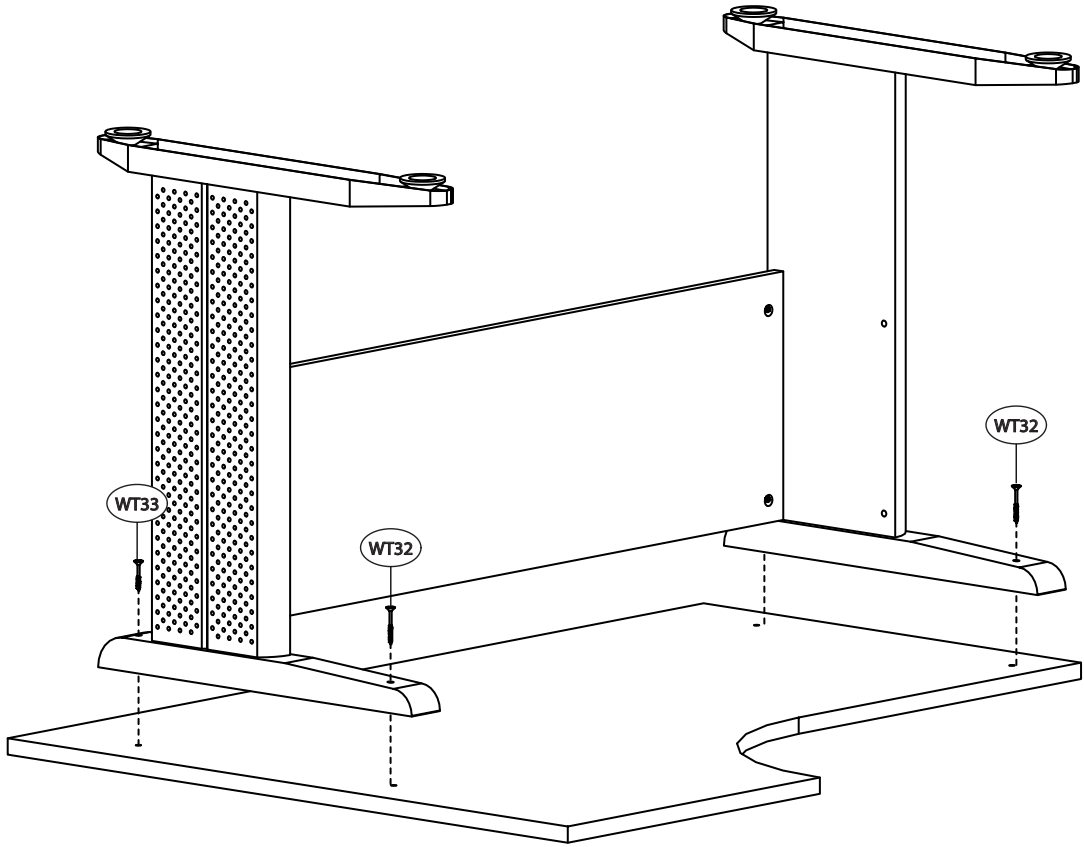

D ▶

